

Crossheads	6
Pediments	18
Pilasters	27
Trim	33
Window Panels	38
Door Surround Kits.....	40
Keystones	44
Shutters	45



Exceptional Entrances

Window & Door Trim

Adding Fypon® window and door trim takes the look of a home from ordinary to extraordinary. Many pieces are designed to work together, and some can even be ordered moulded as one piece to further speed installation. From pilasters, pediments and crossheads, to arches and panels, our architectural options easily enhance a home's design. For installation and finishing instructions, please visit www.fypon.com.

How to Use This Section

The products in this section of the catalog are organized by size, from smallest to largest. Where applicable, part numbers are shown for fabricated products with attached accessories, and matching unattached accessories are referenced or shown with the product.

How to Order

Window Trim

To order window trim, first measure the window unit to be trimmed. Next choose the desired products and accessories to complete the look.

Door Trim & Entrance Systems

When ordering door trim, first measure the door unit to be trimmed. The unit can be measured with or without brick mould; however, the brick mould is essential when using a storm door. Next choose the desired pilaster style and size. Finally, choose a pediment or crosshead that is wide enough to span the opening plus the brick mould and pilasters (see example). Add desired accessories to complete the look.

Door Surround Kits

Specifying a Door Surround Kit is straightforward: Simply answer a few basic questions, such as single door, single door with one sidelite, single door with two sidelites or double door. Pilasters and crossheads come in a variety of styles and sizes to fit any door. The pilaster can be purchased in a plain or fluted design. Coordinating crossheads for the top of the door frame are available with or without a keystone.

Window & Door Trim Accessories

Keystones, dentil trim, trim strip and bottom trim accessories are available attached to standard products as fabricated products. Keystones can also be ordered as unattached accessories by listing the line item on your order.

Window & Door Trim Applications

Window Trim Terminology

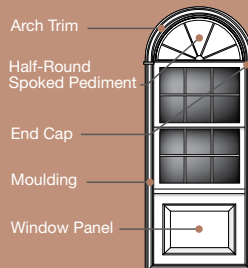

Door Trim Terminology

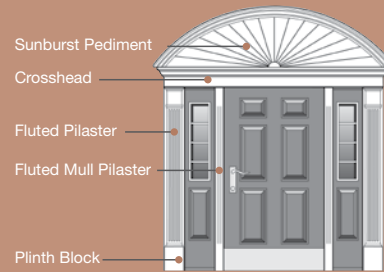

Keystone Options

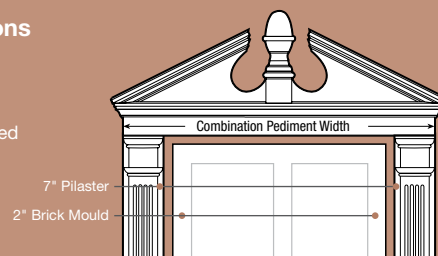

Without Accessories

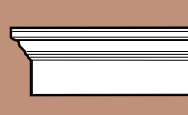

With Accessories

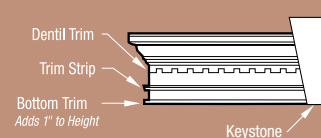

Note: A keystone cannot be used when combining a crosshead with a pediment.

Window Crossheads with Attached Accessories



with Keystone



with Dentil Trim
MLD303 used on 6" Crosshead
MLD304 used on all other Crossheads



with Bottom Trim



with Trim Strip
MLD602



Remember to Order Adhesive

A urethane-based adhesive **must** be used on all joint surfaces. See page 172 to order Loctite® PL Premium® Adhesive.*

* Loctite® PL Premium® is owned by Henkel IP & Holding GmbH.

Always consult the local building code authority to determine suitability of products to meet specific project requirements.

Images are representative of style, actual product will vary by size.

6" Crosshead

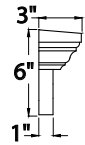
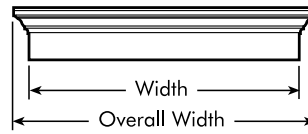

Standard

Width	Overall Width	Part Number
24"	27 1/2"	WCH24X6
28"	31 1/2"	WCH28X6
30"	33 1/2"	WCH30X6
31"	34 1/2"	WCH31X6
32"	35 1/2"	WCH32X6
33 5/8"	37 1/8"	WCH33X6
34"	37 1/2"	WCH34X6
35"	38 1/2"	WCH35X6
36"	39 1/2"	WCH36X6
37 5/8"	41 1/8"	WCH37X6
38"	41 1/2"	WCH38X6
40"	43 1/2"	WCH40X6
41 5/8"	45 1/8"	WCH41X6
43"	46 1/2"	WCH43X6
44"	47 1/2"	WCH44X6
46"	49 1/2"	WCH46X6
47"	50 1/2"	WCH47X6
48"	51 1/2"	WCH48X6
50"	53 1/2"	WCH50X6
51"	54 1/2"	WCH51X6
52"	55 1/2"	WCH52X6
54"	57 1/2"	WCH54X6
56"	59 1/2"	WCH56X6

Width	Overall Width	Part Number
60"	63 1/2"	WCH60X6
64"	67 1/2"	WCH64X6
66"	69 1/2"	WCH66X6
67"	70 1/2"	WCH67X6
68"	71 1/2"	WCH68X6
72"	75 1/2"	WCH72X6
73"	76 1/2"	WCH73X6
74"	77 1/2"	WCH74X6
76"	79 1/2"	WCH76X6
78"	81 1/2"	WCH78X6
79"	82 1/2"	WCH79X6
80"	83 1/2"	WCH80X6
80 1/2"	84"	WCH80.5X6
84"	87 1/2"	WCH84X6
86"	89 1/2"	WCH86X6
87"	90 1/2"	WCH87X6
96"	99 1/2"	WCH96X6
100"	103 1/2"	WCH100X6
103"	106 1/2"	WCH103X6
104"	107 1/2"	WCH104X6
108"	111 1/2"	WCH108X6
110"	113 1/2"	WCH110X6
144"	147 1/2"	WCH144X6

^ This part uses Keystone K6M. Refer to page 44 for more Keystone options.

Crosshead Options

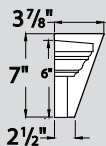

with Keystone K6M[^]

WCH24X6K		
Crosshead	Breastboard Length	Keystone
		Height

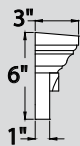

with Dentil Trim

WCH24X6D		
Crosshead	Breastboard Length	Dentil Trim
		Height



with Bottom Trim

WCH24X7BT		
Crosshead	Breastboard Length	Bottom Trim
		Height

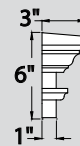

with Trim Strip

WCH24X6T		
Crosshead	Breastboard Length	Trim Strip
		Height

9" Narrow Crosshead

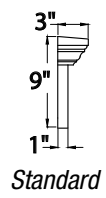

Width	Overall Width	Part Number
32"	35 1/2"	WCH32X9N
36"	39 1/2"	WCH36X9N
37 5/8"	41 1/8"	WCH37X9N
40"	43 1/2"	WCH40X9N
44"	47 1/2"	WCH44X9N
48"	51 1/2"	WCH48X9N
50"	53 1/2"	WCH50X9N
54"	57 1/2"	WCH54X9N
72"	75 1/2"	WCH72X9N
76"	79 1/2"	WCH76X9N
84"	87 1/2"	WCH84X9N
204"	207 1/2"	WCH204X9N

^ This part uses Keystone K9MN. Refer to page 44 for more Keystone options.



Crosshead Options

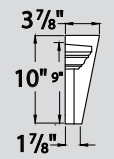

with Keystone
K9MN^

WCH32X9NK

Crosshead	Breastboard	Keystone
	Length	Narrow
		Height

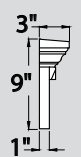

with Dentil Trim

WCH32X9ND

Crosshead	Breastboard	Dentil Trim
	Length	Narrow
		Height

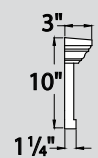

with Bottom Trim

WCH32X10NBT

Crosshead	Breastboard	Bottom Trim
	Length	Narrow
		Height

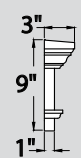

with Trim Strip

WCH32X9NT

Crosshead	Breastboard	Trim Strip
	Length	Narrow
		Height

Parts may be required to ship LTL (less than truckload) based on size and overall dimensions.

9" Crosshead

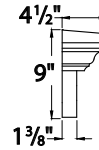
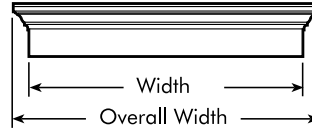

Standard

Width	Overall Width	Part Number
20"	25 1/2"	WCH20X9
24"	29 1/2"	WCH24X9
25 5/8"	31 1/8"	WCH25X9
26"	31 1/2"	WCH26X9
27"	32 1/2"	WCH27X9
28"	33 1/2"	WCH28X9
29 5/8"	35 1/8"	WCH29X9
30 1/4"	35 3/4"	WCH30X9
32"	37 1/2"	WCH32X9
33 5/8"	39 1/8"	WCH33X9
34"	39 1/2"	WCH34X9
35"	40 1/2"	WCH35X9
36"	41 1/2"	WCH36X9
37 5/8"	43 1/8"	WCH37X9
38"	43 1/2"	WCH38X9
40"	45 1/2"	WCH40X9
41 5/8"	47 1/8"	WCH41X9
42"	47 1/2"	WCH42X9

Width	Overall Width	Part Number
43"	48 1/2"	WCH43X9
44"	49 1/2"	WCH44X9
45"	50 1/2"	WCH45X9
46"	51 1/2"	WCH46X9
48"	53 1/2"	WCH48X9
49"	54 1/2"	WCH49X9
50"	55 1/2"	WCH50X9
54"	59 1/2"	WCH54X9
56"	61 1/2"	WCH56X9
58"	63 1/2"	WCH58X9
60"	65 1/2"	WCH60X9
62"	67 1/2"	WCH62X9
64"	69 1/2"	WCH64X9
65"	70 1/2"	WCH65X9
66"	71 1/2"	WCH66X9
67"	72 1/2"	WCH67X9
68"	73 1/2"	WCH68X9
69"	74 1/2"	WCH69X9

^ This part uses Keystone K9M. Refer to page 44 for more Keystone options.

9" Crosshead continued on next page.

Crosshead Options

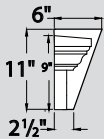

with Keystone K9M[^]

WCH20X9K		
Crosshead	Breastboard Length	Keystone Height

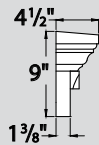

with Dentil Trim

WCH20X9D		
Crosshead	Breastboard Length	Dentil Trim Height

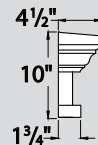

with Bottom Trim

WCH20X10BT		
Crosshead	Breastboard Length	Bottom Trim Height

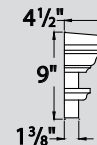

with Trim Strip

WCH20X9T		
Crosshead	Breastboard Length	Trim Strip Height

9" Crosshead

Continued

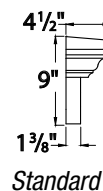
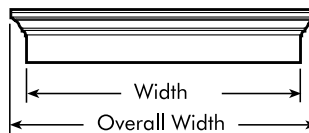

Width	Overall Width	Part Number
70"	75 1/2"	WCH70X9
72"	77 1/2"	WCH72X9
73"	78 1/2"	WCH73X9
74"	79 1/2"	WCH74X9
75"	80 1/2"	WCH75X9
76"	81 1/2"	WCH76X9
77"	82 1/2"	WCH77X9
78"	83 1/2"	WCH78X9
80"	85 1/2"	WCH80X9
81"	86 1/2"	WCH81X9
82"	87 1/2"	WCH82X9
84"	89 1/2"	WCH84X9
85"	90 1/2"	WCH85X9
86"	91 1/2"	WCH86X9
88"	93 1/2"	WCH88X9
90"	95 1/2"	WCH90X9
93"	98 1/2"	WCH93X9
96"	101 1/2"	WCH96X9

Width	Overall Width	Part Number
99"	104 1/2"	WCH99X9
100"	105 1/2"	WCH100X9
101"	106 1/2"	WCH101X9
103"	108 1/2"	WCH103X9
104"	109 1/2"	WCH104X9
108"	113 1/2"	WCH108X9
110"	115 1/2"	WCH110X9
112"	117 1/2"	WCH112X9
113"	118 1/2"	WCH113X9
120"	125 1/2"	WCH120X9
124"	129 1/2"	WCH124X9
144"	149 1/2"	WCH144X9
192"	197 1/2"	WCH192X9
196"	201 1/2"	WCH196X9
197"	202 1/2"	WCH197X9
200"	205 1/2"	WCH200X9
204"	209 1/2"	WCH204X9
207"	212 1/2"	WCH207X9

^ This part uses Keystone K9M. Refer to page 44 for more Keystone options.

Crosshead Options

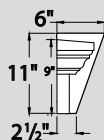

with Keystone K9M[^]

WCH70X9K

Crosshead | Breastboard Length | Keystone Height

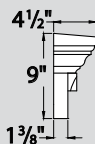

with Dentil Trim

WCH70X9D

Crosshead | Breastboard Length | Dentil Trim Height

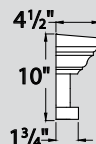

with Bottom Trim

WCH70X10BT

Crosshead | Breastboard Length | Bottom Trim Height

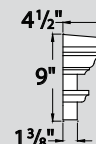

with Trim Strip

WCH70X9T

Crosshead | Breastboard Length | Trim Strip Height

Parts may be required to ship LTL (less than truckload) based on size and overall dimensions.

12" Crosshead

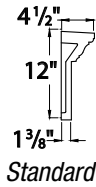

Width	Overall Width	Part Number
36"	41 1/2"	WCH36X12
37 5/8"	43 1/8"	WCH37X12
40"	45 1/2"	WCH40X12
44"	49 1/2"	WCH44X12
48"	53 1/2"	WCH48X12
54"	59 1/2"	WCH54X12
56"	61 1/2"	WCH56X12
64"	69 1/2"	WCH64X12
72"	77 1/2"	WCH72X12
96"	101 1/2"	WCH96X12
102"	107 1/2"	WCH102X12
104"	109 1/2"	WCH104X12
144"	149 1/2"	WCH144X12
200"	205 1/2"	WCH200X12
203"	208 1/2"	WCH203X12
213"	218 1/2"	WCH213X12



^ This part uses Keystone K12M only.

Crosshead Options

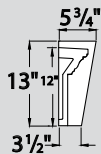

with Keystone K12M[^]

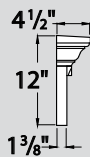
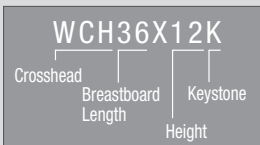

with Dentil Trim

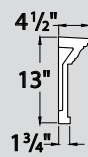
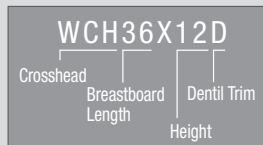

with Bottom Trim

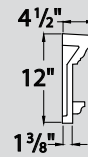
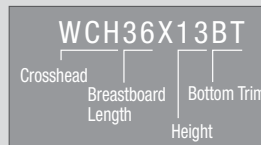

with Trim Strip

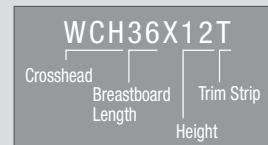



14" Crosshead

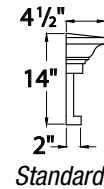
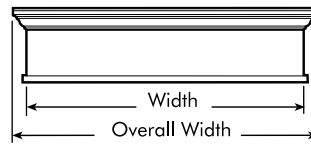

Width	Overall Width	Part Number
36"	41 1/2"	WCH36X14BT
70"	75 1/2"	WCH70X14BT
72"	77 1/2"	WCH72X14BT
76"	81 1/2"	WCH76X14BT
96"	101 1/2"	WCH96X14BT
144"	149 1/2"	WCH144X14BT

NOTE: This part only comes moulded with bottom trim, and can be used with K14M.

6" Crosshead Arch

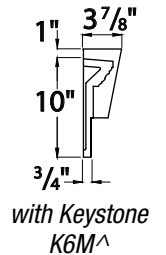
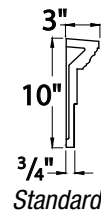
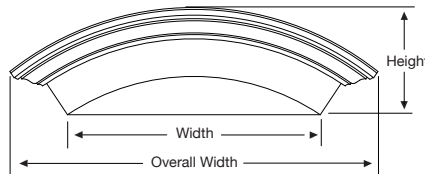

Width	Overall Width	Height	Part Number	Part Number w/ Keystone
34"	42 7/8"	10"	WCH6ARS34X10	WCH6ARS34X10K

^ This part uses Keystone K6M. Refer to page 44 for more Keystone options.

Parts may be required to ship LTL (less than truckload) based on size and overall dimensions.

9" Crosshead Arch

Solid

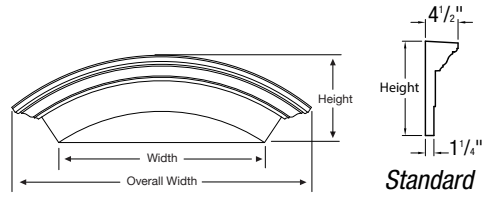

Standard

Width	Overall Width	Height	Part Number
33"	48 1/8"	14"	WCHARS33X14
36"	49 1/4"	13"	WCHARS36X13
43"	55 1/4"	13"	WCHARS43X13
54"	68 1/8"	16"	WCHARS54X16
64"	75 1/2"	14"	WCHARS64X14
68"	77 1/4"	12"	WCHARS68X12
68"	80 7/8"	16"	WCHARS68X16
72"	82 1/8"	13"	WCHARS72X13
75"	84 7/8"	13 3/8"	WCHARS75X13
80"	91 1/4"	15"	WCHARS80X15
84"	95 3/4"	16"	WCHARS84X16
89"	98 3/8"	13"	WCHARS89X13
97"	108 3/4"	17"	WCHARS97X17
101"	110"	13"	WCHARS101X13
108"	119 7/8"	19 1/4"	WCHARS108X19

^ This part uses Keystone K9M. Refer to page 44 for more Keystone options.

Crosshead Options

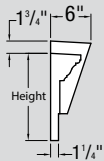

with Keystone K9M^

WCHARS33X14K

Crosshead Breastboard Length Keystone
Height

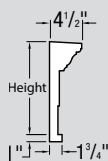

with Bottom Trim

WCHARS33X15BT

Crosshead Breastboard Length Bottom Trim
Height



10" Eyebrow Crosshead

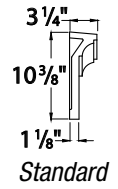
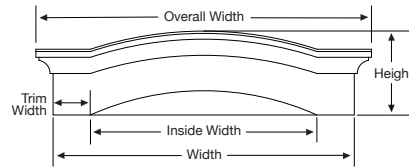

Width	Inside Width	Overall Width	Part Number
37 1/4"	28"	41 1/2"	WCHSEG28X10
39 1/8"	29 7/8"	43 3/8"	WCHSEG30X10
44"	34"	48 1/4"	WCHSEG34X10
45"	36"	49 1/4"	WCHSEG36X10
48"	43"	52 1/4"	WCHSEG43X10
49"	44"	53 1/4"	WCHSEG44X10
73 1/4"	64"	77 1/2"	WCHSEG64X10
81"	72"	85 1/4"	WCHSEG72X10

^ This part uses Keystone K10SEG only.

Crosshead Options

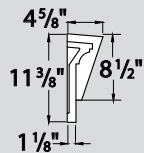

with Keystone K10SEG^

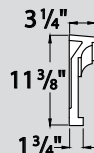
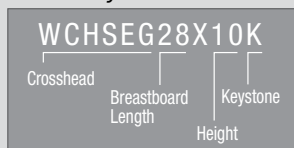

with Bottom Trim

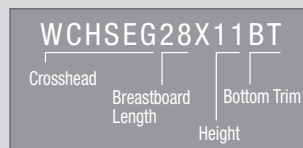

Parts may be required to ship LTL (less than truckload) based on size and overall dimensions.

10" Crosshead

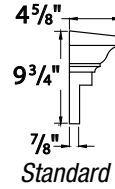
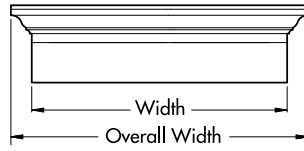

Width	Overall Width	Part Number
32"	37 1/4"	CCA32X10
34"	39 1/4"	CCA34X10
36"	41 1/4"	CCA36X10
40"	45 1/4"	CCA40X10
47"	52 1/4"	CCA47X10
52"	57 1/4"	CCA52X10
64"	69 1/4"	CCA64X10
72"	77 1/4"	CCA72X10
100"	105 1/4"	CCA100X10
106"	111 1/4"	CCA106X10
199"	204 1/4"	CCA199X10
200"	205 1/4"	CCA200X10

^ This part uses Keystone KCCA10 only.

Crosshead Options

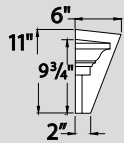

with Keystone KCCA10[^]

CCA32X10K

Crosshead	Breastboard Length	Keystone Height
-----------	--------------------	-----------------

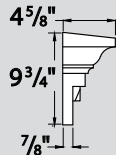

with Dentil Trim

CCA32X10D

Crosshead	Breastboard Length	Dentil Trim Height
-----------	--------------------	--------------------

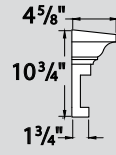

with Bottom Trim

CCA32X11BT

Crosshead	Breastboard Length	Bottom Trim Height
-----------	--------------------	--------------------

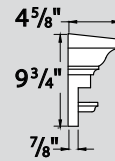

with Trim Strip

CCA32X10T

Crosshead	Breastboard Length	Trim Strip Height
-----------	--------------------	-------------------



8" Crosshead

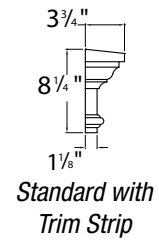
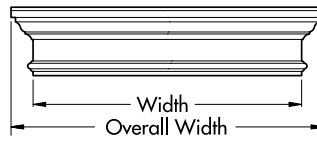

Width	Overall Width	Part Number w/ Trim Strip
24"	29 1/4"	CCB24X8
32"	37 1/4"	CCB32X8
36"	41 1/4"	CCB36X8
40"	45 1/4"	CCB40X8
64"	69 1/4"	CCB64X8
101"	106 1/4"	CCB101X8
198"	203 1/4"	CCB198X8

^ This part uses Keystone KCCB8 only.

Crosshead Options

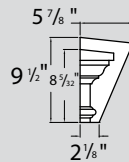

with Keystone KCCB8^

CCB24X8K		
Crosshead	Breastboard Length	Keystone Height

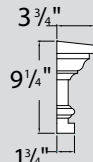

with Bottom Trim

CCB24X9BT		
Crosshead	Breastboard Length	Bottom Trim Height

Parts may be required to ship LTL (less than truckload) based on size and overall dimensions.

8" Craftsman Crosshead

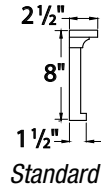
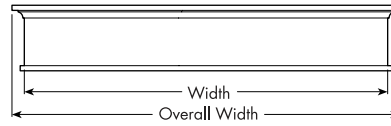

Width	Overall Width	Part Number
48"	51"	CHA48X8BT
204"	207"	CHA204X8BT

13" Craftsman Crosshead

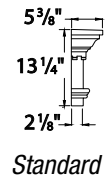
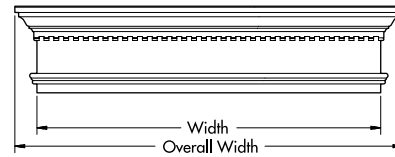

Width	Overall Width	Part Number w/ Dentil Trim & Trim Strip
82"	88 1/2"	CCC82X13

Large Door Crosshead

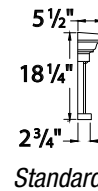
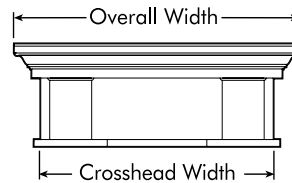

Width	Overall Width	Part Number	Pediment	Pilaster
58"	67 1/2"	LDCH58X18	SP667 Pg. 21 AP667 Pg. 24 RHP667 Pg. 25 PCP667 Pg. 25	All 11" Pilasters
62"	71 1/2"	LDCH62X18	—	
87"	96 1/2"	LDCH87X18	—	
90 1/2"	100"	LDCH90X18	—	
94 1/2"	104"	LDCH94X18	RHP6100 Pg. 25	

NOTE: Large Door Crosshead matches all 11" Pilasters.

For options not shown above, please call Custom Product Sales at 855.397.6647 or fill out our Quote Request Form at www.fypon.com/customquoteform

Parts may be required to ship LTL (less than truckload) based on size and overall dimensions.





Half-Round Sunburst

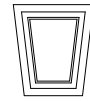
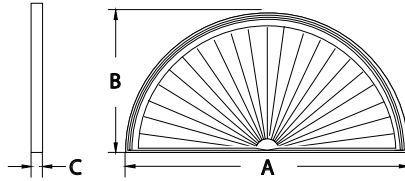

Keystone
KWM180M Page 44

Part Number	Width (A)	Height (B)	Projection (C)	Flat Trim	Decorative Trim
SWDH24X12	24"	12"	1 3/4"	AR24X4F	—
SWDH28X14	28"	14"	1 3/4"	AR28X4F	—
SWDH30X15	30"	15"	1 3/4"	—	—
SWDH32X16	32"	16"	1 3/4"	—	—
SWDH33X17	33 5/8"	16 3/4"	1 3/4"	AR33X4F	—
SWDH36X18	36"	18"	1 3/4"	AR36X4F AR36X6F	AR36X4M, AR36X6M AR36X10MC
SWDH37X19	37 5/8"	18 3/4"	1 3/4"	AR37X4F	AR37X6M
SWDH40X20	40"	20"	1 3/4"	—	AR40X6M DVP40
SWDH42X21	42"	21"	1 3/4"	—	—
SWDH44X22	44"	22"	1 3/4"	—	—
SWDH48X24	48"	24"	1 3/4"	AR48X4F AR48X6F	AR48X4M, AR48X6M AR48X10MC
SWDH52X26	52"	26"	1 3/4"	—	—
SWDH56X28	56"	28"	1 3/4"	AR56X4F	—
SWDH60X30	60"	30"	1 3/4"	AR60X6F	AR60X6M AR60X10MC
SWDH64X32	64"	32"	1 3/4"	—	AR64X10MC
SWDH68X34	68"	34"	1 3/4"	—	—
SWDH72X36	72"	36"	1 3/4"	AR72X4F AR72X6F	AR72X4M AR72X6M
SWDH76X38	76"	38"	1 3/4"	—	—
SWDH100X50	100"	50"	1 3/4"	—	—

Segment Sunburst

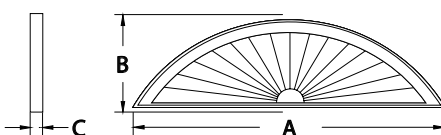

Keystone
KWM180M Page 44

Part Number	Width (A)	Height (B)	Projection (C)
SWDH36X9	36"	9"	1 3/4"
SWDH40X10	40"	10"	1 3/4"
SWDH46X13	46"	13"	1 3/4"
SWDH48X13	48"	13"	1 3/4"
SWDH54X13	54"	13"	1 3/4"
SWDH60X13	59 5/8"	12 1/2"	1 3/4"
SWDH64X13	63 5/8"	13"	1 3/4"
SWDH68X14	67 5/8"	14"	1 3/4"
SWDH72X14	72"	14"	1 3/4"
SWDH76X15	76"	15"	1 3/4"
SWDH78X16	78"	16"	1 3/4"
SWDH80X15	79 1/2"	15"	1 3/4"
SWDH96X17	95 3/8"	17"	1 3/4"
SWDH104X18	104"	18"	1 3/4"

Elliptical Sunburst

with Decorative Trim

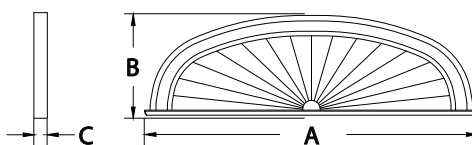

Part Number	Width (A)	Height (B)	Projection (C)
ESWDH76X23	76 7/8"	23"	3 1/2"

Parts may be required to ship LTL (less than truckload) based on size and overall dimensions.



Half-Round Sunburst

with Flat Trim & Keystone

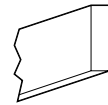
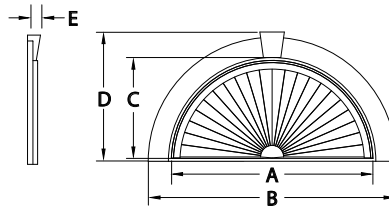

Flat Trim
FLT152

Part Number	Width (A)	Overall Width (B)	Height (C)	Overall Height (D)	Projection (E)
SWDH36X18-4FK	36"	43"	18"	22 1/2"	2 1/4"

Peaked Sunburst

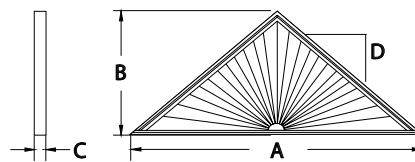

Part Number	Width (A)	Height (B)	Projection (C)	Pitch (D)
PSWDH60X30	60"	30"	1 3/4"	12 / 12
PSWDH78X32	78"	32 1/2"	1 3/4"	10 / 12
PSWDH84X28	84"	28"	1 3/4"	8 / 12

Half-Round Spoked Pediment

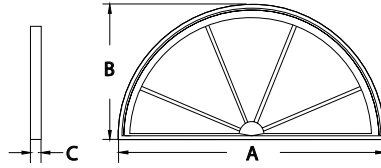

Part Number	Width (A)	Height (B)	Projection (C)	Flat Trim	Decorative Trim
HRSP36X18	36"	18"	1 3/4"	AR36X4F AR36X6F	AR36X4M, AR36X6M AR36X10MC
HRSP48X24	48"	24"	1 3/4"	AR48X4F AR48X6F	AR48X4M, AR48X6M AR48X10MC
HRSP72X36	72"	36"	1 3/4"	AR72X4F AR72X6F	AR72X4M AR72X6M

Sunburst Pediment

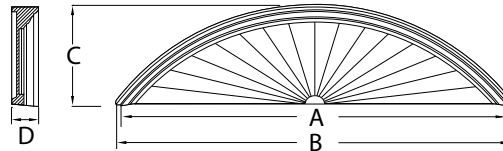

Part Number	Width (A)	Overall Width (B)	Height (C)	Projection (D)	Crosshead
SP56	55 1/4"	57"	16 3/4"	4 1/2"	WCH50X9
SP667	66 3/4"	69 1/4"	20 3/8"	5 1/2"	LDCH58X18 LDCH62X18
SP86	85 5/8"	87 1/4"	22 1/2"	4 1/2"	WCH81X9
SP91	90 1/2"	92 1/2"	26"	4 1/2"	WCH86X9
SP98	98 1/4"	100"	24"	4 3/8"	WCH90X9 WCH93X9

Combination Sunburst Pediment

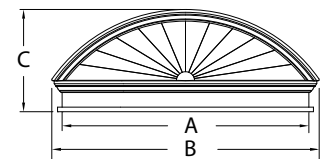
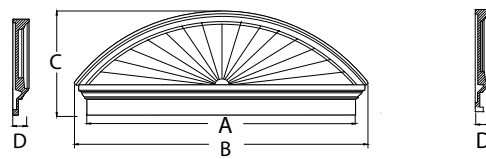

Part Number	Width (A)	Overall Width (B)	Height (C)	Projection (D)	Breastboard Thickness	Part Number w/ Bottom Trim
CSP50	50"	54 1/2"	20 3/4"	3 1/8"	1"	CSP50BT
CSP54	54"	58 1/2"	21 3/8"	3 1/8"	1"	CSP54BT
CSP75	75"	79 5/8"	23 3/4"	3 1/8"	1"	CSP75BT
CSP80	80"	84 5/8"	25 1/2"	3 1/8"	1"	CSP80BT
CSP85	85"	89 1/2"	26 3/8"	3 1/8"	1"	CSP85BT

NOTE: Bottom trim adds 1" to overall height.

Parts may be required to ship LTL (less than truckload) based on size and overall dimensions.

Combination Acorn Pediment



NOTE: Acorn ships unattached in carton.

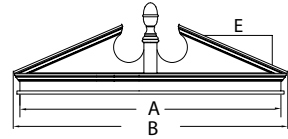
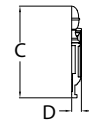
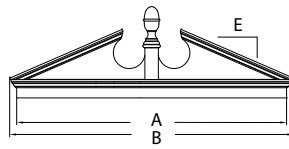
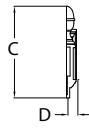

Part Number	Width (A)	Overall Width (B)	Overall Height (C)	Projection (D)	Pitch (E)	Part Number w/ Bottom Trim
CAP47E [^]	47"	50 1/8"	13 5/8"	2 1/8"	5 / 12	—
CAP50	50"	54 1/2"	21 1/8"	3 1/8"	6 / 12	CAP50BT
CAP54	54"	58 1/2"	21 3/8"	3 1/8"	6 / 12	CAP54BT
CAP58	58"	62 1/2"	21 3/4"	3 1/8"	6 / 12	CAP58BT
CAP67	67 1/2"	72"	24 1/8"	3"	6 / 12	CAP67BT
CAP75	75"	79 1/2"	25 1/8"	3 1/8"	6 / 12	CAP75BT
CAP80	80"	84 7/16"	25 3/8"	3 1/8"	5 1/2 / 12	CAP80BT
CAP85	85"	89 3/8"	28 3/4"	3 1/8"	5 / 12	CAP85BT

NOTE: Bottom trim adds 1" to overall height.

[^] Economy style; does not have breastboard. Accessories cannot be added.

Combination Peaked Cap Pediment

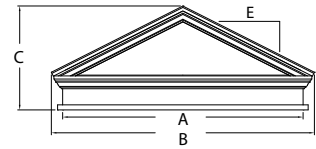
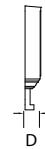
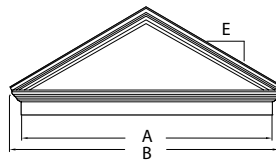
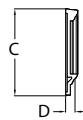

Part Number	Width (A)	Overall Width (B)	Overall Height (C)	Projection (D)	Pitch (E)	Breastboard Thickness	Part Number w/ Bottom Trim
CPCP48	47 1/2"	52"	19 1/2"	3 1/8"	6 / 12	1"	CPCP48BT
CPCP50	50"	54 1/2"	20 1/4"	3 1/8"	6 / 12	1"	CPCP50BT
CPCP54	54"	58 1/4"	21"	3 1/8"	6 / 12	1"	CPCP54BT
CPCP58	58"	62 3/8"	22"	3 1/8"	6 / 12	1"	CPCP58BT
CPCP67	67 1/2"	72"	24 1/2"	3 1/8"	6 / 12	1"	CPCP67BT
CPCP75	75"	79 1/2"	26 1/4"	3 1/8"	6 / 12	1"	CPCP75BT
CPCP80	80"	84 1/2"	27 5/8"	3 1/8"	6 / 12	1"	CPCP80BT
CPCP85	85"	89 1/2"	28 3/4"	3 1/8"	6 / 12	1"	CPCP85BT

NOTE: Bottom trim adds 1" to overall height.

Combination Peaked Cap Pediment

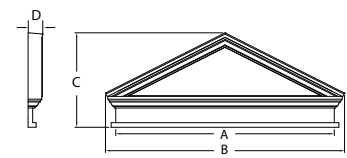
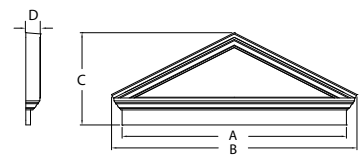

Part Number	Width (A)	Overall Width (B)	Height (C)	Projection (D)	Part Number w/ Bottom Trim
CCP37	37 5/8"	41 3/4"	20 1/2"	4 1/2"	CCP37BT

Combination Rams Head Pediment



NOTE: Urn ships unattached in carton.

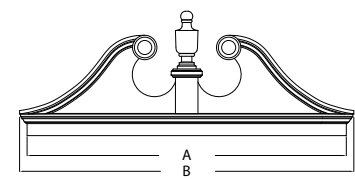
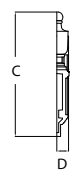

Part Number	Width (A)	Overall Width (B)	Overall Height (C)	Projection (D)	Breastboard Thickness	Part Number w/ Bottom Trim
CRHP50	50"	54"	23 3/4"	3 1/8"	1"	CRHP50BT
CRHP54	54"	58"	23 1/2"	3 1/8"	1"	CRHP54BT
CRHP67	67 1/2"	71 1/2"	27"	3 1/8"	1"	CRHP67BT
CRHP75	75"	79"	29 1/8"	3 1/8"	1"	CRHP75BT
CRHP80	80"	84"	35 3/4"	3 1/8"	1"	CRHP80BT
CRHP85	85"	89"	33 5/8"	3 1/8"	1"	CRHP85BT

NOTE: Bottom trim adds 1" to overall height.



Parts may be required to ship LTL (less than truckload) based on size and overall dimensions.

Combination Segment Arch Pediment

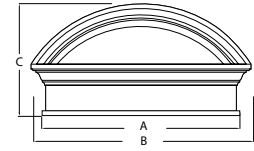
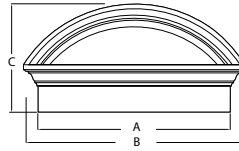

Part Number	Width (A)	Overall Width (B)	Height (C)	Projection (D)	Part Number w/ Bottom Trim
CSAP36	36"	41 1/2"	20"	4 1/2"	CSAP36BT
CSAP38	38"	43 1/2"	20"	4 1/2"	CSAP38BT
CSAP48	48"	53 1/2"	22 1/2"	4 1/2"	CSAP48BT
CSAP65	65"	70 1/2"	28 3/8"	4 1/2"	CSAP65BT
CSAP84	84"	89 1/2"	28"	4 1/2"	CSAP84BT

Acorn Pediment



NOTE: Acorn ships unattached in carton.

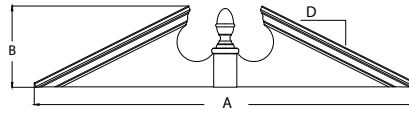

Part Number	Overall Width (A)	Overall Height (B)	Projection (C)	Pitch (D)	Crosshead
AP56	57"	16 5/8"	4 1/2"	6 1/2 / 12	WCH50X9
AP61	62"	16 3/4"	4 1/2"	7 / 12	WCH54X9 WCH56X9
AP667	68 7/8"	23 1/4"	5 1/2"	12 / 12	LDCH58X18 LDCH62X18
AP86	87 1/4"	24"	4 1/2"	7 / 12	WCH81X9
AP91	92 1/8"	24 1/2"	4 1/2"	6 / 12	WCH86X9
AP98	99 1/8"	24 1/2"	4 1/2"	6 / 12	WCH90X9 WCH93X9



Acorn Pediment

Adjustable



NOTE: Ships in 4 pieces.

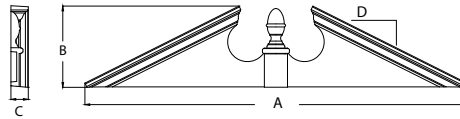

Part Number	Overall Width (A)	Overall Height (B)	Projection (C)	Pitch (D)	Crosshead
AP115	105"-115"	25 5/8"	4 1/2"	6 / 12	9" WCH from 100"-110"

Rams Head Pediment



NOTE: Urn ships unattached in carton.

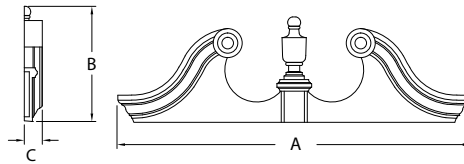

Part Number	Overall Width (A)	Overall Height (B)	Projection (C)	Crosshead
RHP56	60 7/8"	19 1/8"	4 1/2"	WCH50X9
RHP86	93 1/4"	29 1/2"	4 1/2"	WCH81X9

Rams Head Pediment

with Decorative Trim



NOTE: Urn ships unattached in carton.

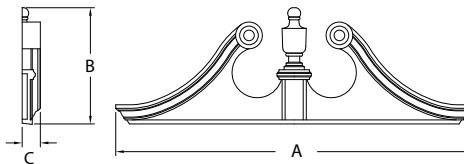

Part Number	Overall Width (A)	Overall Height (B)	Projection (C)	Crosshead
RHP667	73 1/2"	21 1/2"	5 1/2"	LDCH58X18 LDCH62X18
RHP6100	107 1/4"	29 3/8"	5 1/2"	LDCH90X18 LDCH94X18

Peaked Cap Pediment

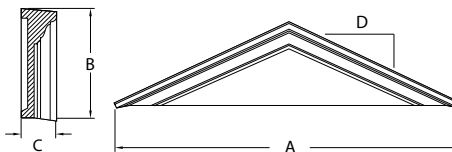

Part Number	Overall Width (A)	Overall Height (B)	Projection (C)	Pitch (D)	Crosshead
PCP56	56 1/2"	13 5/8"	4 1/2"	5 1/2 / 12	WCH50X9
PCP667	68 3/4"	23 5/8"	5 1/2"	8 / 12	LDCH58X18 LDCH62X18

Parts may be required to ship LTL (less than truckload) based on size and overall dimensions.



Deluxe Victorian Pediment

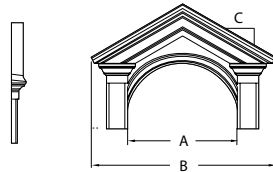

Part Number	Inside Width (A)	Inside Height	Overall Width (B)	Radius	Pitch (C)	Accessories
DVP40	40"	24 1/2"	67 1/4"	20"	7 / 12	PIL8X90P, PIL8X108P SWDH40X20

7" Panel Arch *with Sunburst & Keystone*

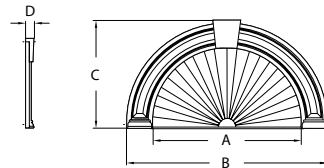

Part Number	Sunburst Width (A)	Overall Width (B)	Height (C)	Radius	Keystone Projection (D)	Pilaster
AR40X54PSK	40"	54"	29"	20"	2 5/8"	PIL7X90DP^

^ PIL7X90DP matches this arch profile *only*.

10" Decorative Arch

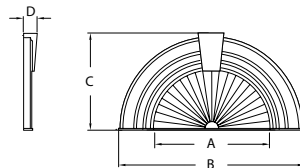

Part Number	Sunburst Width (A)	Overall Width (B)	Height (C)	Radius	Keystone Projection (D)	Pilaster
AR36X10SK	36"	56"	30 1/8"	2 1/8"	4"	PIL10X96A^ PIL10X192A^

^ This arch matches PIL10X96A and PIL10X192A *only*.

Plain Pilaster

Moulded with Plinth

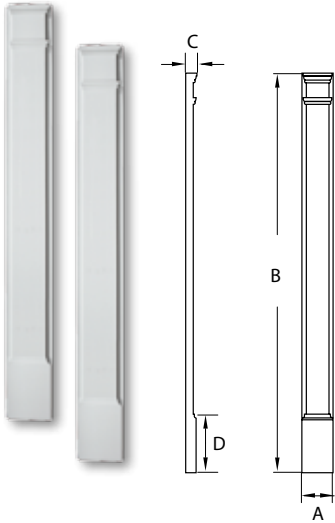

Part Number	Width (A)	Height (B)	Projection (C)	Plinth Block Height (D)
PIL5X90P	5 1/4"	90"	1 5/8"	10 1/8"
PIL6X90P	6"	90"	2 1/2"	13 1/4"
PIL7X90P	7"	90"	2 1/2"	13 1/4"
PIL8X90P	8"	90"	2 1/2"	13 1/4"
PIL9X90P	9"	90"	3"	14 1/2"
PIL11X90P	11"	90"	3 1/2"	13 1/4"

NOTE: Sold in pairs

Plain Economy Pilaster

Moulded with Plinth

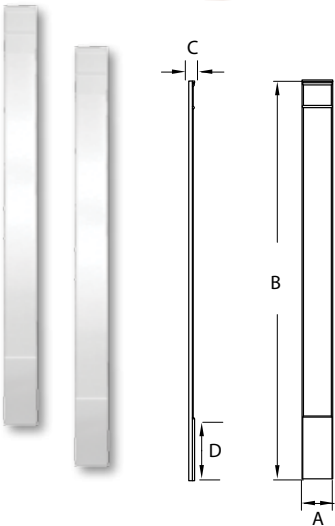

Part Number	Width (A)	Height (B)	Projection (C)	Plinth Block Height (D)
PIL7X90PE	7"	90"	1 1/4"	14 1/4"

NOTE: Sold in pairs



Parts may be required to ship LTL (less than truckload) based on size and overall dimensions.

Plain Pilaster

Two-Piece Adjustable

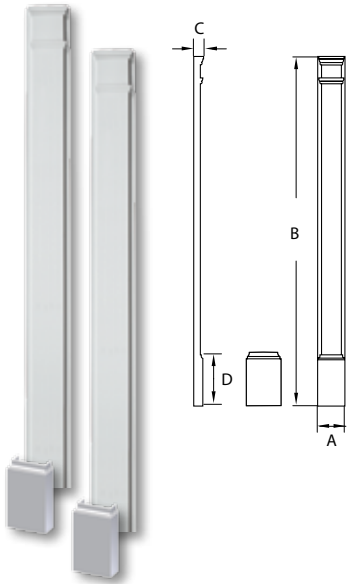

Part Number	Width (A)	Height (B)	Projection (C)	Plinth Block Height (D)
PIL5X108P	5 1/4"	108"	1 5/8"	10"
PIL6X120P	6"	120"	2 1/2"	13 1/4"
PIL7X108P	7"	108"	2 1/2"	13"
PIL7X120P	7"	120"	2 1/2"	13"
PIL8X108P	8"	108"	2 5/8"	13"
PIL9X108P	9"	108"	3"	14 1/2"
PIL9X120P	9"	120"	3"	14 1/2"
PIL10X120P	10"	120"	3 1/4"	14 1/2"
PIL11X96P	11"	96"	3 1/2"	14 1/2"
PIL11X108P	11"	108"	3 1/2"	14 1/2"
PIL11X109P	11"	109"	3 1/2"	14 1/2"
PIL11X120P	11"	120"	3 1/2"	14 1/2"

NOTE: Sold in pairs.

Double Panel Pilaster

Moulded with Plinth

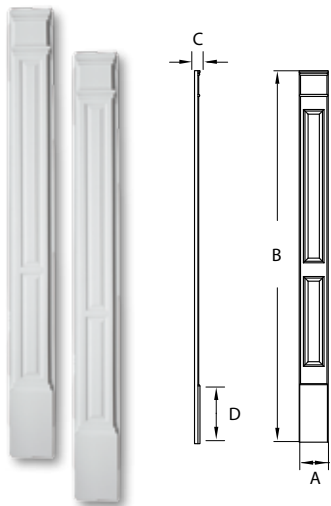

Part Number	Width (A)	Height (B)	Projection (C)	Plinth Block Height (D)
PIL5X90DP	5 1/4"	90"	1 5/8"	10 1/8"
PIL7X90DP	7"	90"	2 1/2"	13 1/4"
PIL9X90DP	9"	90"	3"	14 1/2"
PIL9X100DP	9"	100"	3"	14 1/2"
PIL11X90DP	11"	90"	3 1/2"	14 1/2"
PIL11X108DP	11"	108"	3 1/2"	14 1/2"

NOTE: Sold in pairs.

Double Panel Economy Pilaster

Moulded with Plinth

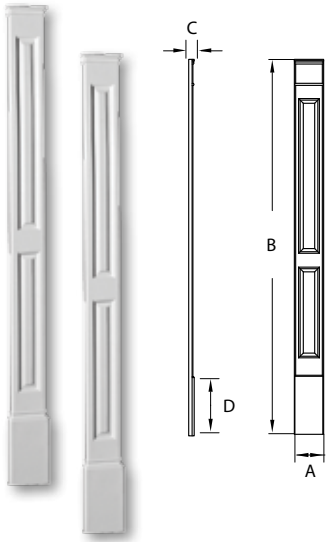

Part Number	Width (A)	Height (B)	Projection (C)	Plinth Block Height (D)
PIL7X90DPE	7"	90"	1 1/4"	14 1/4"

NOTE: Sold in pairs.

Fluted Pilaster

Moulded with Plinth

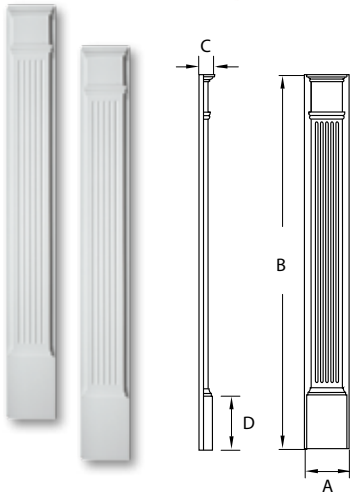

Part Number	Width (A)	Height (B)	Projection (C)	Plinth Block Height (D)
PIL3X81	3 1/2"	81"	1 5/8"	10"
PIL4X83	4 1/2"	82 3/4"	1 5/8"	7 3/4"
PIL4X86	4 1/2"	86"	1 5/8"	11"
PIL4X90	4 1/2"	90"	1 5/8"	10"
PIL5X82	5 1/4"	82"	1 3/4"	8"
PIL5X90	5 1/4"	90"	1 3/4"	10 1/8"
PIL6X90	6 1/4"	90"	2 1/2"	13 1/4"
PIL7X90	7"	90"	2 1/2"	13 1/4"
PIL9X90	9"	90"	3"	14 1/2"
PIL11X90	11"	90"	3 1/2"	14 1/2"

NOTE: Sold in pairs.

Parts may be required to ship LTL (less than truckload) based on size and overall dimensions.

Fluted Economy Pilaster

Moulded with Plinth

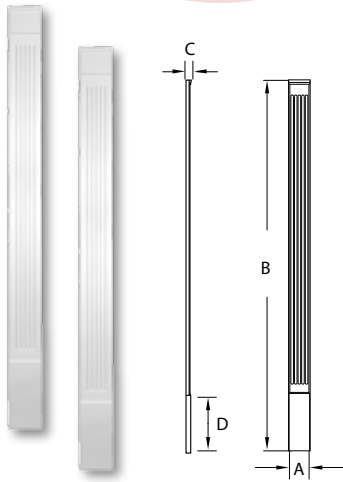

Part Number	Width (A)	Height (B)	Projection (C)	Plinth Block Height (D)
PIL3X90E	3"	90"	1 1/4"	14 1/4"
PIL5X90E	5 1/4"	90"	1 1/4"	14 1/4"
PIL7X90E	7"	90"	1 1/4"	14 1/4"
PIL9X90E	9"	90"	1 1/4"	14 1/4"

NOTE: Sold in pairs.

Fluted Pilaster

Two-Piece Adjustable

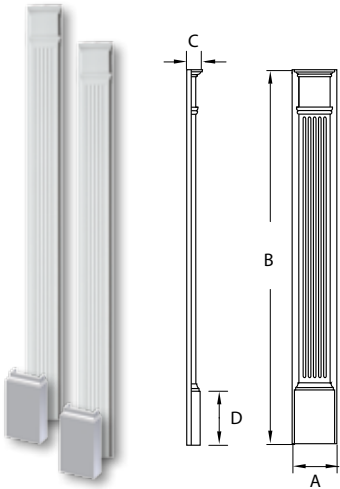

Part Number	Width (A)	Height (B)	Projection (C)	Plinth Block Height (D)
PIL3X108	3 1/2"	108"	1 5/8"	10"
PIL4X108	4 1/2"	108"	1 5/8"	10"
PIL5X108	5 1/4"	108"	1 5/8"	10"
PIL6X108	6 1/4"	108"	2 1/2"	13 1/4"
PIL6X144	6 1/4"	144"	2 1/2"	13 1/4"
PIL7X102	7"	102"	2 1/2"	13 1/4"
PIL7X108	7"	108"	2 1/2"	13"
PIL7X144	7"	144"	2 1/2"	13"
PIL8X90	8"	90"	2 1/2"	13"
PIL8X108	8"	108"	2 1/2"	13"
PIL8X144	8"	144"	2 1/2"	13"
PIL9X102	9"	102"	3"	14 1/2"
PIL9X108	9"	108"	3"	14 1/2"
PIL9X144	9"	144"	3"	14 1/2"
PIL11X108	11"	108"	3 1/2"	14 1/2"
PIL11X120	11"	120"	3 1/2"	14 1/2"
PIL11X144	11"	144"	3 1/2"	14 1/2"

NOTE: Sold in pairs.

Fluted Economy Pilaster

Two-Piece Adjustable

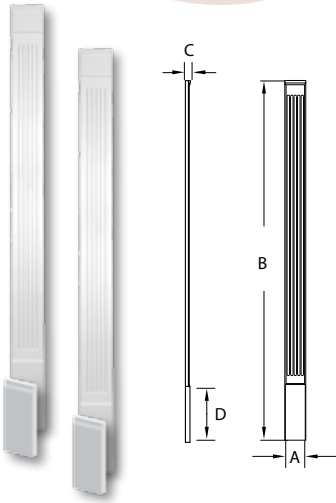

Part Number	Width (A)	Height (B)	Projection (C)	Plinth Block Height (D)
PIL5X120E	5 1/4"	120"	1 1/4"	14 1/4"
PIL7X120E	7"	120"	1 1/4"	14 1/4"

NOTE: Sold in pairs.

Arch Profile Pilaster

Matches 10M Decorative Arches

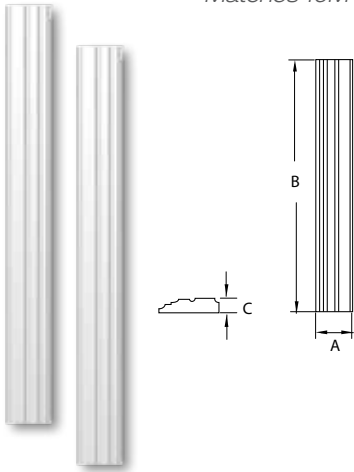

Part Number	Width (A)	Height (B)	Projection (C)
PIL10X96A	10"	96"	2 3/8"
PIL10X192A	10"	192"	2 3/8"

NOTE: Sold in pairs. See page 26 and 37 for matching arches.

Half-Round Pilaster

Adjustable Column

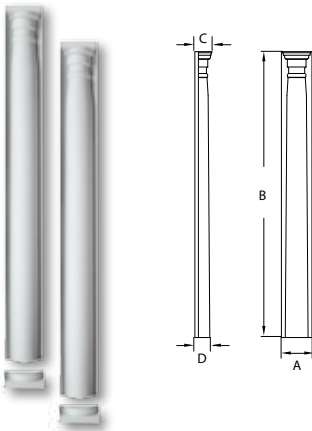

Part Number	Width (A)	Shaft Height [^] (B)	Top Projection (C)	Bottom Projection (D)
PIL10X96HC	10"	93 5/8"	4 7/8"	5 1/2"

NOTE: Sold in pairs.

[^] Overall height is adjustable from 80"-96". Shaft sits on top of plinth, which is 3" in height.

Parts may be required to ship LTL (less than truckload) based on size and overall dimensions.

Fluted Mull

Moulded with Plinth

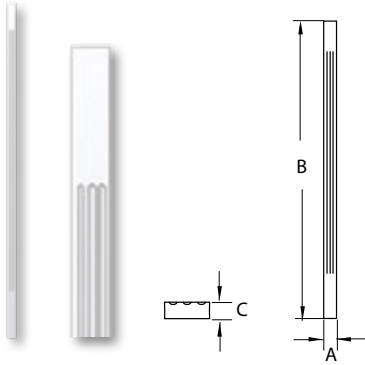

Part Number	Width (A)	Height (B)	Projection (C)
PIL2X86M	2"	86"	1"

NOTE: Sold in pairs.

Fluted Panel Trim

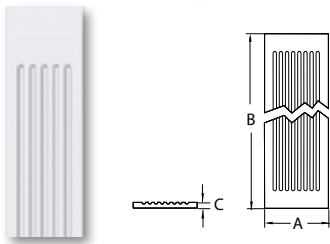

Part Number	Width (A)	Height (B)	Projection (C)
FP9X168 [^]	8 1/2"	168"	1 1/4"
FP12X96	12"	96"	1 1/2"

[^] Actual product has flutes running the full length on this size *only*.



Half-Round Arch Trim

4F Flat

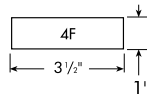
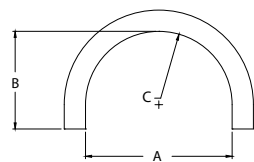

Accessories



Keystone
K4TF



Keystone
KP4TF



Flat Trim
FLT152



Plinth Block
PB4X4

Part Number	Inside Width (A)	Inside Height (B)	Radius (C)
AR24X4F	24 1/8"	16 1/8"	12 1/8"
AR28X4F	28 1/2"	18 1/4"	14 1/4"
AR33X4F	33 5/8"	20 3/4"	16 3/4"
AR36X4F	36"	22"	18"
AR37X4F	37 5/8"	22 3/4"	18 3/4"
AR41X4F	41 5/8"	24 3/4"	20 3/4"
AR48X4F	48"	28"	24"
AR56X4F	56 1/2"	32 1/4"	28 1/4"
AR67X4F	67 1/4"	37 3/4"	33 3/4"
AR72X4F	72"	40"	36"
AR75X4F	75 1/4"	41 3/4"	37 3/4"

NOTE: This part uses Keystones K4TF and KP4TF only.

Half-Round Arch Trim

4M Decorative

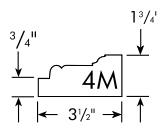
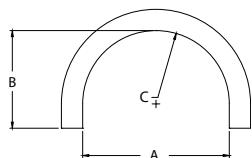

Accessories



Keystone
K4TM



Keystone
KP4TM



Moulding
MLD215

Part Number	Inside Width (A)	Inside Height (B)	Radius (C)
AR36X4M	36"	22"	18"
AR48X4M	48"	28"	24"
AR72X4M	71 7/8"	40"	36"

NOTE: This part uses Keystones K4TM and KP4TM only.

For options not shown above, please call Custom Product Sales at 855.397.6647 or fill out our Quote Request Form at www.fypon.com/customquoteform

Parts may be required to ship LTL (less than truckload) based on size and overall dimensions.

Half-Round Arch Trim

6F Flat

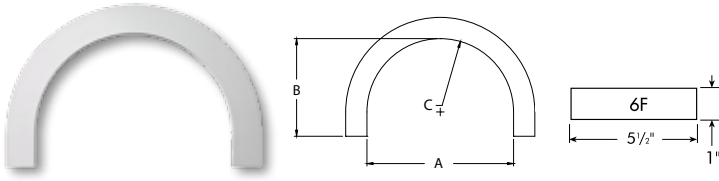

Accessories

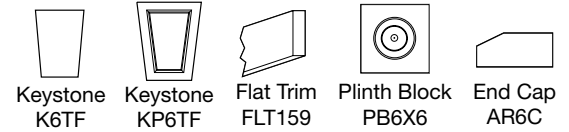

Part Number	Inside Width (A)	Inside Height (B)	Radius (C)
AR36X6F	36"	22"	18"
AR48X6F	48"	28"	24"
AR60X6F	60"	34"	30"
AR72X6F	72"	40"	36"

NOTE: This part uses Keystones K6TF and KP6TF only.

Half-Round Arch Trim

6M Decorative

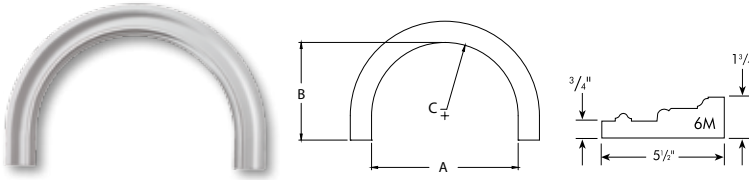

Accessories

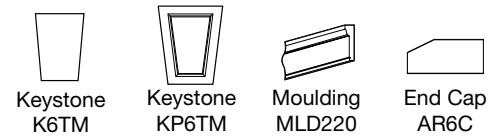

Part Number	Inside Width (A)	Inside Height (B)	Radius (C)
AR36X6M	36"	22 1/8"	18 1/8"
AR37X6M	37 5/8"	22 3/4"	18 3/4"
AR40X6M	40"	24"	20"
AR48X6M	48"	28"	24"
AR60X6M	60"	34"	30"
AR72X6M	72"	40"	36"

NOTE: This part uses Keystones K6TM and KP6TM only.

End Cap

for 6F & 6M Arch Trim

	Part Number	Width (A)	Projection (B)	Height (C)	
	AR6C	6"	2"	5/8"	

NOTE: Sold in pairs.

Parts may be required to ship LTL (less than truckload) based on size and overall dimensions.



Elliptical Trim

4F Flat

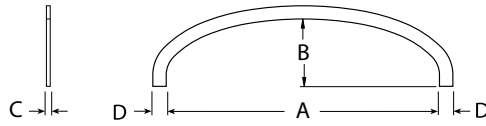
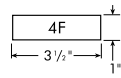

Part Number	Inside Width (A)	Inside Height (B)	Projection (C)	Trim Width (D)	Accessories
AR72X4FET	71 3/8"	17 7/8"	1"	3 1/2"	K4TF KP4TF

NOTE: This part uses Keystones K4TF and KP4TF only.

Circle Trim

4F Flat

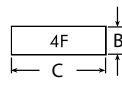
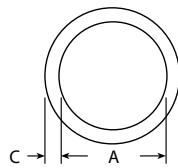
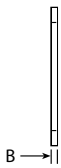

Part Number	Inside Width (A)	Projection (B)	Trim Width (C)
CIR24X4F	24 1/4"	1"	3 1/2"
CIR36X4F	36 1/8"	1"	3 1/2"

Oval Trim

4F Flat

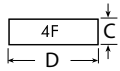
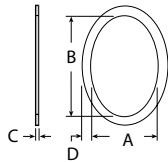

Part Number	Inside Width (A)	Inside Height (B)	Projection (C)	Trim Width (D)
OV20X28X4F	19 7/8"	28 1/2"	1"	3 1/2"
OV24X36X4F	24 1/8"	36 1/8"	1"	3 1/2"

Oval Trim

4M Decorative

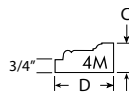
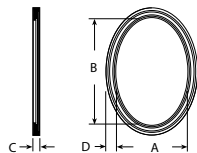

Part Number	Inside Width (A)	Inside Height (B)	Projection (C)	Trim Width (D)
OV24X36X4M	24 1/8"	36 1/8"	1 3/4"	3 1/2"



Half-Round Arch Trim

10M Decorative

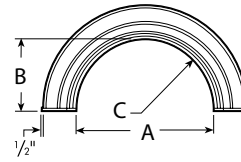
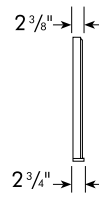

Accessories

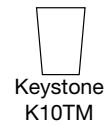

Part Number	Inside Width (A)	Inside Height (B)	Radius (C)
AR36X10MC	36"	18 3/4"	18"
AR48X10MC	48"	24 3/4"	24"
AR60X10MC	60"	30 3/4"	30"
AR64X10MC	64"	32 3/4"	32"

Half-Round Arch with Flankers

10M Decorative

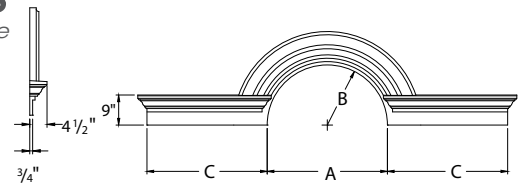

Part Number	Inside Width (A)	Inside Height / Radius (B)	Flanker Width (C)	Overall Width (D)	Accessories
AR36X10MFL108	36"	18"	36"	108"	K10TM SWDH36X18

Parts may be required to ship LTL (less than truckload) based on size and overall dimensions.



Window Panel

Flat Panel

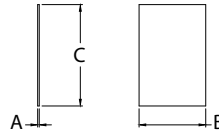

Part Number	Thickness (A)	Width (B)	Height (C)
FLT40X96	1"	40"	96"
WDP48X73F	1 1/8"	48"	73"

Window Panel

Trimable Raised Panel

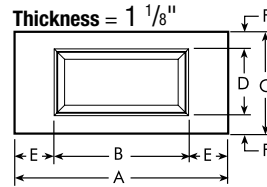

Part Number	Overall Width (A)	Panel Width (B)	Overall Height (C)	Panel Height (D)	Border Width (E)	Border Height (F)
WDP38X18ADJ	38"	24"	18"	12"	7"	3"
WDP43X13ADJ	43"	27 5/8"	13"	9 1/2"	7 3/4"	1 3/4"



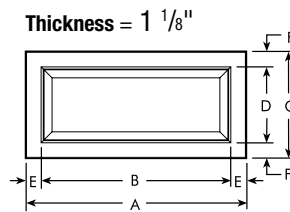

Window Panel

Raised Panel

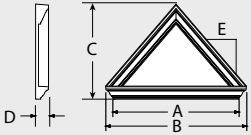

Part Number	Overall Width (A)	Panel Width (B)	Overall Height (C)	Panel Height (D)	Border Width (E)	Border Height (F)
WDP32X13	32"	23 7/8"	13"	4 7/8"	4 1/8"	4 1/8"
WDP36X12	36"	31"	12"	7"	2 1/2"	2 1/2"
WDP36X18	36"	28"	18"	10"	4"	4"
WDP36X24	36"	28"	23 5/8"	15 5/8"	4"	4"
WDP41X24	41 3/4"	30 1/4"	24 3/4"	13 3/4"	5 3/4"	5 1/2"
WDP85X24	85"	81"	24"	20"	2"	2"

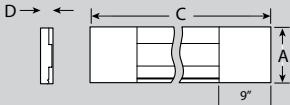
Dormer Trim System

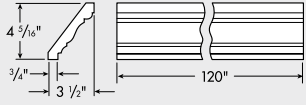

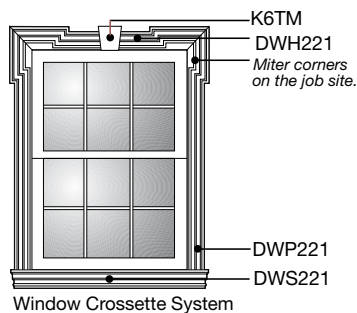
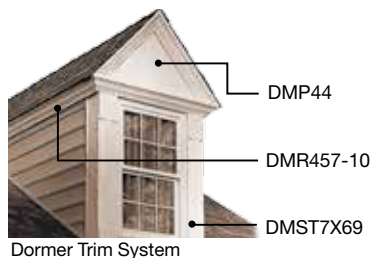

Part Number	Width (A)	Overall Width (B)	Overall Height (C)	Projection (D)	Pitch (E)	
 DMP44 Pediment	43 3/4"	49 1/4"	33 1/4"	4 1/2"	14 / 12	
 DMST7X69 Side Trim Set	6 3/4"	—	68 5/8"	1 1/2"	—	
 DMR457-10 Return	—	—	—	—	—	



MLD221
MLD221 can be used as a header in place of DWH221 to avoid a center seam.

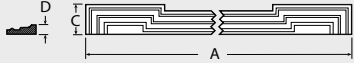

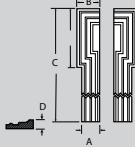
Window Crosssette System

Part Number	Width (A)	Overall Width (B)	Overall Height (C)	Projection (D)	
 DWH221 Header	132"	—	7"	1 3/4"	
 DWP221 Pilaster Set	5 1/2"	7"	114"	1 3/4"	
 DWS221 Sill	94"	96"	5 1/2"	1 3/4"	

Parts may be required to ship LTL (less than truckload) based on size and overall dimensions.

Plain Door Surround Kits



Door is not included in kit.



Single Door With Keystone										
Door Style	Part Number	Sidelite Width	Pilaster	Pilaster Width	Crosshead	Crosshead Width	Keystone	Door Unit Width Dimension Range (A)	Outside Dimension of DSK (B)	Crosshead Can be Trimmed
	DSKS05P516K	—	PIL5X108P	5"	WCH51X6	51"	K6M	Up to 40 1/2"	51"	YES
	DSKS07P569K	—	PIL7X108P	7"	WCH56X9	56"	K9M	Up to 42"	56"	YES
	DSKS07P5612K	—	PIL7X108P	7"	WCH56X12	56"	K12M	Up to 42"	56"	YES
	DSKS08P589K	—	PIL8X108P	8"	WCH58X9	58"	K9M	Up to 42"	58"	YES
	DSKS08P6412K	—	PIL8X108P	8"	WCH64X12	64"	K12M	Up to 48"	64"	YES
Single Door Without Keystone										
	DSKS05P516	—	PIL5X108P	5"	WCH51X6	51"	—	37 1/2" - 40 1/2"	51"	NO
	DSKS07P569	—	PIL7X108P	7"	WCH56X9	56"	—	40"-42"	56"	NO
	DSKS07P5612	—	PIL7X108P	7"	WCH56X12	56"	—	40"-42"	56"	NO
	DSKS08P589	—	PIL8X108P	8"	WCH58X9	58"	—	40"-42"	58"	NO
	DSKS08P6412	—	PIL8X108P	8"	WCH64X12	64"	—	46"-48"	64"	NO

Single Door 1 Sidelite With Keystone											
Door Style	Part Number	Sidelite Width	Pilaster	Pilaster Width	Crosshead	Crosshead Width	Keystone	Door Unit Width Dimension Range (A)	Outside Dimension of DSK (B)	Crosshead Can be Trimmed	
	DSKS105P646K	10"	PIL5X108P	5"	WCH64X6	64"	K6M	Up to 53 1/2"	64"	YES	
	DSKS107P679K	10"	PIL7X108P	7"	WCH67X9	67"	K9M	Up to 53"	67"	YES	
	DSKS108P699K	10"	PIL8X108P	8"	WCH69X9	69"	K9M	Up to 53"	69"	YES	
	DSKS105P646K	12"	PIL5X108P	5"	WCH64X6	64"	K6M	Up to 53 1/2"	64"	YES	
	DSKS107P689K	12"	PIL7X108P	7"	WCH68X9	68"	K9M	Up to 54"	68"	YES	
	DSKS108P709K	12"	PIL8X108P	8"	WCH70X9	70"	K9M	Up to 54"	70"	YES	
	DSKS105P666K	14"	PIL5X108P	5"	WCH66X6	66"	K6M	Up to 55 1/2"	66"	YES	
	DSKS15P676K	10"	PIL5X108P	5"	WCH67X6	67"	K6M	Up to 56 1/2"	67"	YES	
	DSKS17P709K	14"	PIL7X108P	7"	WCH70X9	70"	K9M	Up to 56"	70"	YES	
	DSKS17P7212K	12"	PIL7X108P	7"	WCH72X12	72"	K12M	Up to 58"	72"	YES	
	DSKS18P729K	14"	PIL8X108P	8"	WCH72X9	72"	K9M	Up to 56"	72"	YES	
	DSKS18P7212K	14"	PIL8X108P	8"	WCH72X12	72"	K12M	Up to 56"	72"	YES	
	Single Door 1 Sidelite Without Keystone										
		DSKS107P679	10"	PIL7X108P	7"	WCH67X9	67"	—	51"-53"	67"	NO
		DSKS108P699	10"	PIL8X108P	8"	WCH69X9	69"	—	51"-53"	69"	NO
	DSKS105P646	12"	PIL5X108P	5"	WCH64X6	64"	—	51 1/2"-53 1/2"	64"	NO	
	DSKS107P689	12"	PIL7X108P	7"	WCH68X9	68"	—	52"-54"	68"	NO	
	DSKS108P709	12"	PIL8X108P	8"	WCH70X9	70"	—	52"-54"	70"	NO	
	DSKS105P666	14"	PIL5X108P	5"	WCH66X6	66"	—	53 1/2"-55 1/2"	66"	NO	
	DSKS15P676	10"	PIL5X108P	5"	WCH67X6	67"	—	54 1/2"-56 1/2"	67"	NO	
	DSKS17P709	14"	PIL7X108P	7"	WCH70X9	70"	—	54"-56"	70"	NO	
	DSKS17P7212	12"	PIL7X108P	7"	WCH70X9	72"	—	56"-58"	72"	NO	
	DSKS18P729	14"	PIL8X108P	8"	WCH72X9	72"	—	54"-56"	72"	NO	
	DSKS18P7212	14"	PIL8X108P	8"	WCH72X12	72"	—	54"-56"	72"	NO	



Single Door | 2 Sidelites | With Keystone

Door Style	Part Number	Sidelite Width	Pilaster	Pilaster Width	Crosshead	Crosshead Width	Keystone	Door Unit Width Dimension Range (A)	Outside Dimension of DSK (B)	Crosshead Can be Trimmed
	DSKS205P746K	10"	PIL5X108P	5"	WCH74X6	74"	K6M	Up to 63½"	74"	YES
	DSKS207P779K	10"	PIL7X108P	7"	WCH77X9	77"	K9M	Up to 63"	77"	YES
	DSKS208P809K	10"	PIL8X108P	8"	WCH80X9	80"	K9M	Up to 64"	80"	YES
	DSKS205P786K	12"	PIL5X108P	5"	WCH78X6	78"	K6M	Up to 67½"	78"	YES
	DSKS207P819K	12"	PIL7X108P	7"	WCH81X9	81"	K9M	Up to 67"	81"	YES
	DSKS208P849K	12"	PIL8X108P	8"	WCH84X9	84"	K9M	Up to 68"	84"	YES
	DSKS25P846K	14"	PIL5X108P	5"	WCH84X6	84"	K6M	Up to 73½"	84"	YES
	DSKS27P869K	14"	PIL7X108P	7"	WCH86X9	86"	K9M	Up to 72"	86"	YES
	DSKS27P9612K	12"	PIL7X108P	7"	WCH96X12	96"	K12M	Up to 82"	96"	YES
	DSKS28P889K	14"	PIL8X108P	8"	WCH88X9	88"	K9M	Up to 72"	88"	YES
	DSKS28P9612K	14"	PIL8X108P	8"	WCH96X12	88"	K12M	Up to 80"	96"	YES

Single Door | 2 Sidelites | Without Keystone

	DSKS205P746	10"	PIL5X108P	5"	WCH74X6	74"	—	61½"-63½"	74"	NO
	DSKS207P779	10"	PIL7X108P	7"	WCH77X9	77"	—	61"-63"	77"	NO
	DSKS208P809	10"	PIL8X108P	8"	WCH80X9	80"	—	62"-64"	80"	NO
	DSKS205P786	12"	PIL5X108P	5"	WCH78X6	78"	—	65½"-67½"	78"	NO
	DSKS207P819	12"	PIL7X108P	7"	WCH81X9	81"	—	65"-67"	81"	NO
	DSKS208P849	12"	PIL8X108P	8"	WCH84X9	84"	—	66"-68"	84"	NO
	DSKS25P846	12"	PIL8X108P	8"	WCH84X9	84"	—	71½"-73½"	84"	NO
	DSKS27P869	10"	PIL5X108P	7"	WCH84X6	84"	—	70"-72"	84"	NO
	DSKS27P9612	12"	PIL7X108P	7"	WCH96X12	96"	—	80"-82"	96"	NO
	DSKS28P889	14"	PIL8X108P	8"	WCH88X9	88"	—	70"-72"	88"	NO
	DSKS28P9612	14"	PIL8X108P	8"	WCH96X12	96"	—	78"-80"	96"	NO

Double Door | With Keystone

Door Style	Part Number	Sidelite Width	Pilaster	Pilaster Width	Crosshead	Crosshead Width	Keystone	Door Unit Width Dimension Range (A)	Outside Dimension of DSK (B)	Crosshead Can be Trimmed
	DSKD05P966K	—	PIL5X108P	5"	WCH96X6	96"	K6M	Up to 85½"	96"	YES
	DSKD07P939K	—	PIL7X108P	7"	WCH93X9	93"	K9M	Up to 79"	93"	YES
	DSKD07P9612K	—	PIL7X108P	7"	WCH96X12	96"	K12M	Up to 80"	99"	YES
	DSKD08P969K	—	PIL8X108P	8"	WCH96X9	96"	K9M	Up to 80"	96"	YES
	DSKD08P9612K	—	PIL8X108P	8"	WCH96X12	96"	K12M	Up to 80"	96"	YES

Double Door | Without Keystone

	DSKD05P966	—	PIL5X108P	5"	WCH96X6	96"	—	83½"-85½"	96"	NO
	DSKD07P939	—	PIL7X108P	7"	WCH93X9	93"	—	77"-79"	93"	NO
	DSKD07P9612	—	PIL7X108P	7"	WCH96X12	96"	—	80"-82"	96"	NO
	DSKD08P969	—	PIL8X108P	7"	WCH96X9	96"	—	78"-80"	96"	NO
	DSKD08P9612	—	PIL8X108P	7"	WCH96X12	96"	—	78"-80"	96"	NO

Parts may be required to ship LTL (less than truckload) based on size and overall dimensions.

Fluted Door Surround Kits



Door is not included in kit.



Single Door With Keystone										
Door Style	Part Number	Sidelite Width	Pilaster	Pilaster Width	Crosshead	Crosshead Width	Keystone	Door Unit Width Dimension Range (A)	Outside Dimension of DSK (B)	Crosshead Can be Trimmed
	DSKCRT3068	—	—	5 1/4"	—	50"	—	Up to 36"	50"	NO
	DSKS05F516K	—	PIL5X108	5"	WCH51X6	51"	K6M	Up to 40 1/2"	51"	YES
	DSKCOL3068	—	PIL6X85	6"	WCH53X9K	53"	—	Up to 40"	53"	NO
	20020	—	PIL7X90	7"	WCH54X9	54"	K9M	Up to 40"	54"	YES
	DSKS07F569K	—	PIL7X108	7"	WCH56X9	56"	K9M	Up to 42"	56"	YES
	DSKS07F5612K	—	PIL7X108	7"	WCH56X12	56"	K12M	Up to 42"	56"	YES
	DSKS08F589K	—	PIL8X108	8"	WCH58X9	58"	K9M	Up to 42"	58"	YES
	DSKS08F6412K	—	PIL8X108	8"	WCH64X12	64"	K12M	Up to 48"	64"	YES
Single Door Without Keystone										
	DSKS05F516	—	PIL5X108	5"	WCH51X6	51"	—	37 1/2" - 40 1/2"	51"	NO
	DSKEMP3068	—	PIL7X90DP	7"	WCHARS54X16	54"	—	40"	54"	NO
	DSKS07F569	—	PIL7X108	7"	WCH56X9	56"	—	40"-42"	56"	NO
	DSKS07F5612	—	PIL7X108	7"	WCH56X12	56"	—	40"-42"	56"	NO
	DSKS08F589	—	PIL8X108	8"	WCH58X9	58"	—	40"-42"	58"	NO
	DSKS08F6412	—	PIL8X108	8"	WCH64X12	64"	—	46"-48"	64"	NO

Single Door 1 Sidelite With Keystone											
Door Style	Part Number	Sidelite Width	Pilaster	Pilaster Width	Crosshead	Crosshead Width	Keystone	Door Unit Width Dimension Range (A)	Outside Dimension of DSK (B)	Crosshead Can be Trimmed	
	DSKS105F646K	10"	PIL5X108	5"	WCH64X6	64"	K6M	Up to 53 1/2"	64"	YES	
	DSKS107F679K	10"	PIL7X108	7"	WCH67X9	67"	K9M	Up to 53"	67"	YES	
	DSKS108F699K	10"	PIL8X108	8"	WCH69X9	69"	K9M	Up to 53"	69"	YES	
	DSKS105F646K	12"	PIL5X108	5"	WCH64X6	64"	K6M	Up to 53 1/2"	64"	YES	
	DSKS107F689K	12"	PIL7X108	7"	WCH68X9	68"	K9M	Up to 54"	68"	YES	
	DSKS108F709K	12"	PIL8X108	8"	WCH70X9	70"	K9M	Up to 54"	70"	YES	
	DSKS105F666K	14"	PIL5X108	5"	WCH66X6	66"	K6M	Up to 55 1/2"	66"	YES	
	DSKS15F676K	10"	PIL5X108	5"	WCH67X6	67"	K6M	Up to 56 1/2"	67"	YES	
	DSKS17F709K	14"	PIL7X108	7"	WCH70X9	70"	K9M	Up to 56"	70"	YES	
	DSKS17F7212K	12"	PIL7X108	7"	WCH72X12	72"	K12M	Up to 58"	72"	YES	
	DSKS18F729K	14"	PIL8X108	8"	WCH72X9	72"	K9M	Up to 56"	72"	YES	
	DSKS18F7212K	14"	PIL8X108	8"	WCH72X12	72"	K12M	Up to 56"	72"	YES	
	Single Door 1 Sidelite Without Keystone										
		DSKS107F679	10"	PIL7X108	7"	WCH67X9	67"	—	51"-53"	67"	NO
		DSKS108F699	10"	PIL8X108	8"	WCH69X9	69"	—	51"-53"	69"	NO
		DSKS105F646	12"	PIL5X108	5"	WCH64X6	64"	—	51 1/2"-53 1/2"	64"	NO
	DSKS107F689	12"	PIL7X108	7"	WCH68X9	68"	—	52"-54"	68"	NO	
	DSKS108F709	12"	PIL8X108	8"	WCH70X9	70"	—	52"-54"	70"	NO	
	DSKS105F666	14"	PIL5X108	5"	WCH66X6	66"	—	53 1/2"-55 1/2"	66"	NO	
	DSKS15F676	10"	PIL5X108	5"	WCH67X6	67"	—	54 1/2"-56 1/2"	67"	NO	
	DSKS17F709	14"	PIL7X108	7"	WCH70X9	70"	—	54"-56"	70"	NO	
	DSKS17F7212	12"	PIL7X108	7"	WCH72X12	72"	—	56"-58"	72"	NO	
	DSKS18F729	14"	PIL8X108	8"	WCH72X9	72"	—	54"-56"	72"	NO	
	DSKS18F7212	14"	PIL8X108	8"	WCH72X12	72"	—	54"-56"	72"	NO	



Single Door | 2 Sidelites | With Keystone

Door Style	Part Number	Sidelite Width	Pilaster	Pilaster Width	Crosshead	Crosshead Width	Keystone	Door Unit Width Dimension Range (A)	Outside Dimension of DSK (B)	Crosshead Can Be Trimmed
	DSKS205F746K	10"	PIL5X108	5"	WCH74X6	74"	K6M	Up to 63 1/2"	74"	YES
	DSKS207F779K	10"	PIL7X108	7"	WCH77X9	77"	K9M	Up to 63"	77"	YES
	DSKS208F809K	10"	PIL8X108	8"	WCH80X9	80"	K9M	Up to 64"	80"	YES
	DSKS205F786K	12"	PIL5X108	5"	WCH78X6	78"	K6M	Up to 67 1/2"	78"	YES
	DSKS207F819K	12"	PIL7X108	7"	WCH81X9	81"	K9M	Up to 67"	81"	YES
	DSKS208F849K	12"	PIL8X108	8"	WCH84X9	84"	K9M	Up to 68"	84"	YES
	DSKS25F846K	14"	PIL5X108	5"	WCH84X6	84"	K6M	Up to 73 1/2"	84"	YES
	DSKS27F869K	14"	PIL7X108	7"	WCH86X9	86"	K9M	Up to 72"	86"	YES
	DSKS27F9612K	12"	PIL7X108	7"	WCH96X12	96"	K12M	Up to 82"	96"	YES
	DSKS28F889K	14"	PIL8X108	8"	WCH88X9	88"	K9M	Up to 72"	88"	YES
	DSKS28F9612K	14"	PIL8X108	8"	WCH96X12	96"	K12M	Up to 80"	96"	YES

Single Door | 2 Sidelites | Without Keystone

	DSKS205F746	10"	PIL5X108	5"	WCH74X6	74"	—	61 1/2"-63 1/2"	74"	NO
	DSKS207F779	10"	PIL7X108	7"	WCH77X9	77"	—	61"-63"	77"	NO
	DSKS208F809	10"	PIL8X108	8"	WCH80X9	80"	—	62"-64"	80"	NO
	DSKS205F786	12"	PIL5X108	5"	WCH78X6	78"	—	65 1/2"-67 1/2"	78"	NO
	DSKS207F819	12"	PIL7X108	7"	WCH81X9	81"	—	65"-67"	81"	NO
	DSKS208F849	12"	PIL8X108	8"	WCH84X9	84"	—	66"-68"	84"	NO
	DSKS25F846	10"	PIL5x108	5"	WCH84X6	84"	—	71 1/2"-73 1/2"	84"	NO
	DSKS27F869	14"	PIL7X108	7"	WCH86X9	86"	—	70"-72"	86"	NO
	DSKS27F9612	12"	PIL7X108	7"	WCH96X12	96"	—	80"-82"	96"	NO
	DSKS28F889	14"	PIL8X108	8"	WCH88X9	88"	—	70"-72"	88"	NO
	DSKS28F9612	14"	PIL8X108	8"	WCH88X9	96"	—	78"-80"	96"	NO

Double Door | With Keystone

Door Style	Part Number	Sidelite Width	Pilaster	Pilaster Width	Crosshead	Crosshead Width	Keystone	Door Unit Width Dimension Range (A)	Outside Dimension of DSK (B)	Crosshead Can Be Trimmed
	DSKD05F966K	—	PIL5X108	5"	WCH96X6	96"	K6M	Up to 85 1/2"	96"	YES
	DSKD07F939K	—	PIL7X108	7"	WCH93X9	93"	K9M	Up to 79"	93"	YES
	DSKD07F9612K	—	PIL7X108	7"	WCH96X12	96"	K12M	Up to 82"	96"	YES
	DSKD08F969K	—	PIL8X108	8"	WCH96X9	96"	K9M	Up to 80"	96"	YES
	DSKD08F9612K	—	PIL8X108	8"	WCH96X12	96"	K12M	Up to 80"	96"	YES







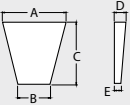
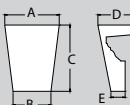

Double Door | Without Keystone

	DSKD05F966	—	PIL5x108	5"	WCH96X6	93"	—	83 1/2"-85 1/2"	96"	NO
	DSKD07F9612	—	PIL7x108	7"	WCH96X12	93"	—	82"-84"	96"	NO
	DSKD07F939	—	PIL7X108	7"	WCH93X9	93"	—	77"-79"	93"	NO
	DSKD08F9612	—	PIL8x108	8"	WCH96X12	93"	—	78"-80"	96"	NO
	DSKD08F969	—	PIL8x108	8"	WCH96X9	93"	—	78"-80"	96"	NO

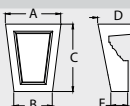
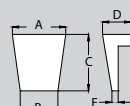
Parts may be required to ship LTL (less than truckload) based on size and overall dimensions.

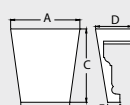
Keystones

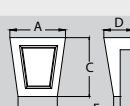
for Trim Profiles

	Part Number	Top Width (A)	Bottom Width (B)	Height (C)	Top Projection (D)	Bottom Projection (E)	Arches & Trim	
	K6*	4 3/4"	2 3/4"	6 1/2"	2 1/4"	1 5/8"	—	
	K8*	9 3/4"	5 3/4"	7 3/4"	2 1/4"	1 1/4"	—	
	K6M	5 3/4"	4"	7"	3 7/8"	1 1/2"	6" WCH, 6" WCH w/ BT	
	K9M	8"	6"	11"	6 1/8"	1 1/8"	9" WCH, 9" WCH w/ BT	
	K9MN	8"	6 1/4"	10"	3 7/8"	7/8"	9" Narrow WCH	
	K10SEG	8"	6"	8 1/2"	4 5/8"	3/4"	10" WCHSEG	
	K12M	8 1/2"	6"	13"	5 3/4"	2 1/8"	12" WCH	
	KCCA10	8"	6"	11"	6"	1 1/8"	10" CCA	
	KCCB8	7 3/4"	6"	9 1/2"	5 7/8"	1"	8" CCB	
	K14M	10"	8"	15"	6"	1"	14" WCH w/ BT	
	KP6M	5 3/4"	4"	7"	4 1/8"	1 3/4"	6" WCH, 6" WCH w/ BT	
	KP9M	8"	6"	11"	6 1/4"	1 5/8"	9" WCH, 9" WCH w/ BT	
	K4TF	4 1/4"	3"	4 1/2"	2 1/4"	1/2"	4F Arches FLT152	
	K5TF	6"	4"	10"	2 1/4"	1/4"	5F Trim	
	K6TF	6"	4"	7"	2 3/8"	5/8"	6F Arches FLT159	
	K8TF	7"	5"	8 7/8"	2 1/2"	3/4"	FLT162	
	K4TM	4 1/4"	3"	4 1/2"	2 1/4"	3/4"	4M Arches MLD215	
	K6TM	6"	4"	7"	2 3/8"	7/8"	6M Arches MLD220 DWH221	
	K10TM	8"	5 1/2"	11 1/2"	4"	1 3/4"	10M Arch Trim PIL10X96A PIL10X192A	
	KP4TF	4 1/4"	3"	4 1/2"	2 1/4"	1/2"	4F Arches FLT152	
	KP6TF	6"	4"	7"	2 3/8"	5/8"	6F Arches FLT159	
	KP4TM	4 1/4"	3"	4 1/2"	2 3/4"	3/4"	4M Arch Trim MLD215	
	KP6TM	6"	4"	7"	2 1/2"	7/8"	6M Arch Trim MLD220 DWH221	
	KWM180M	2 3/4"	2"	3 1/8"	2 1/2"	—	Brick Mould Louvers / Trim MLDWM180	

NOTE: Moulded on back side to fit decorative and flat trim profiles.

* Keystones K6 and K8 are not moulded on back side.



Louvered Shutter

without Center Rail

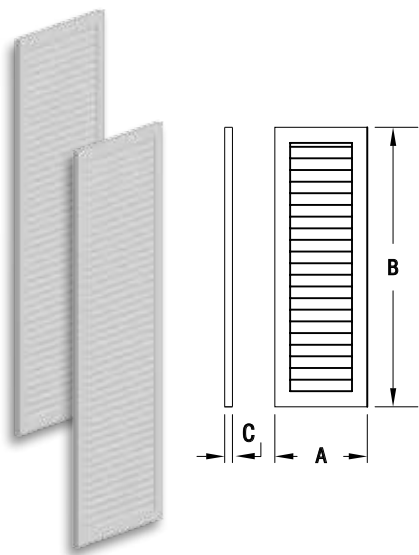

Part Number	Width (A)	Height (B)	Projection (C)
LVSH12X36FNB	12"	36"	1"
LVSH12X42FNB	12"	42"	1"
LVSH16X54FNB	16"	54"	1"
LVSH16X60FNB	16"	60"	1"
LVSH16X72FNB	16"	72"	1"
LVSH18X54FNB	18"	54"	1"
LVSH18X60FNB	18"	60"	1"
LVSH18X62FNB	18"	62"	1"
LVSH18X66FNB	18"	66"	1"
LVSH18X72FNB	18"	72"	1"
LVSH24X60FNB	24"	60"	1"
LVSH24X72FNB	24"	72"	1"

NOTE: This is a style without a centerboard.

NOTE: Sold in pairs.

Parts may be required to ship LTL (less than truckload) based on size and overall dimensions.

Louvered Shutter

with Center Rail

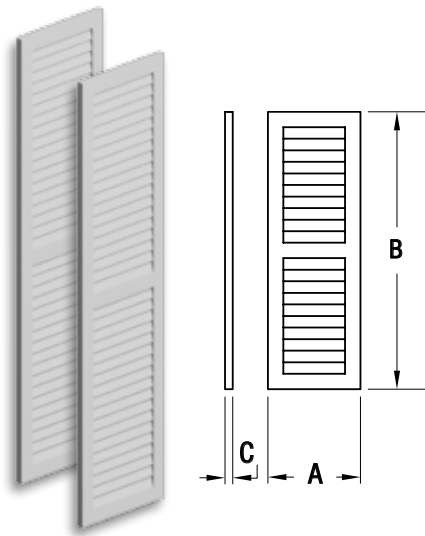

Part Number	Width (A)	Height (B)	Projection (C)
LVSH12X36FNCR	12"	36"	1"
LVSH12X48FNCR	12"	48"	1"
LVSH16X54FNCR	16"	54"	1"
LVSH16X60FNCR	16"	60"	1"
LVSH16X72FNCR	16"	72"	1"
LVSH18X60FNCR	18"	60"	1"
LVSH18X66FNCR	18"	66"	1"
LVSH18X72FNCR	18"	72"	1"
LVSH24X60FNCR	24"	60"	1"
LVSH24X72FNCR	24"	72"	1"

NOTE: Sold in pairs.

Raised Panel Shutter

Double Panel

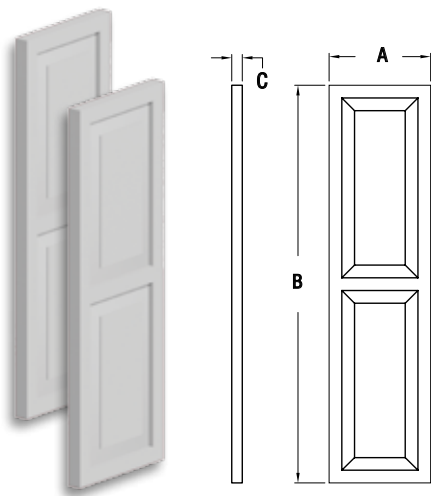

Part Number	Width (A)	Height (B)	Projection (C)
SH16X48DP	16"	48"	1 1/4"
SH16X54DP	16"	54"	1 1/4"
SH16X60DP	16"	60"	1 1/4"
SH16X65DP	16"	65"	1 1/4"
SH16X72DP	16"	72"	1 1/4"
SH18X53DP	18"	53"	1 1/4"
SH18X59DP	18"	59"	1 1/4"
SH18X66DP	18"	66"	1 1/4"
SH18X72DP	18"	72"	1 1/4"

NOTE: Sold in pairs.

For options not shown above, please call Custom Product Sales at 855.397.6647 or fill out our Quote Request Form at www.fypon.com/customquoteform

Parts may be required to ship LTL (less than truckload) based on size and overall dimensions.



8777